

ケース型番 / Product Number

ALGF - - K20 -

W H D タイプ 色記号

Type Color code

W・H・D 寸法制限範囲 / Dimension limit range		
W	H	D
251 ~ 300	30 ~ 500	201 ~ 300

色仕様(型番末尾□) / Color Type(End of product number □)	
記号 / Code	コーナーガード / Corner guard
B	ブラック / Black
G	グレー / Gray

構成内容 / Components

No.	名称 / Part name	数量 / Pcs	材質 / Material	色・表面処理 / Color・Finish
1	上下カバー Top and Bottom cover	各1 1 each	アルミ板 A1100P t2.0 Aluminium A1100P t2.0	シルバーアルマイト Silver・Anodized
2	Wパネル W panel	2	アルミ板 A1100P t2.0 Aluminium A1100P t2.0	シルバーアルマイト Silver・Anodized
3	Dパネル D panel	2	アルミ板 A1100P t2.0 Aluminium A1100P t2.0	シルバーアルマイト Silver・Anodized
4	支柱 Extruded pillar	4	アルミ押出材 A6063S-T5 Extruded aluminium A6063S-T5	シルバーアルマイト Silver・Anodized
5	取付ビス(六角穴付皿M4 x 12) Screw (Hexagonal M4 - 12)	8	ステンレス Stainless steel	無処理 Unfinished
6	コーナーガード Corner guard	8	TPE	ブラック、グレー Black, Gray

■六角レンチ付です。
Hexagonal wrench included.

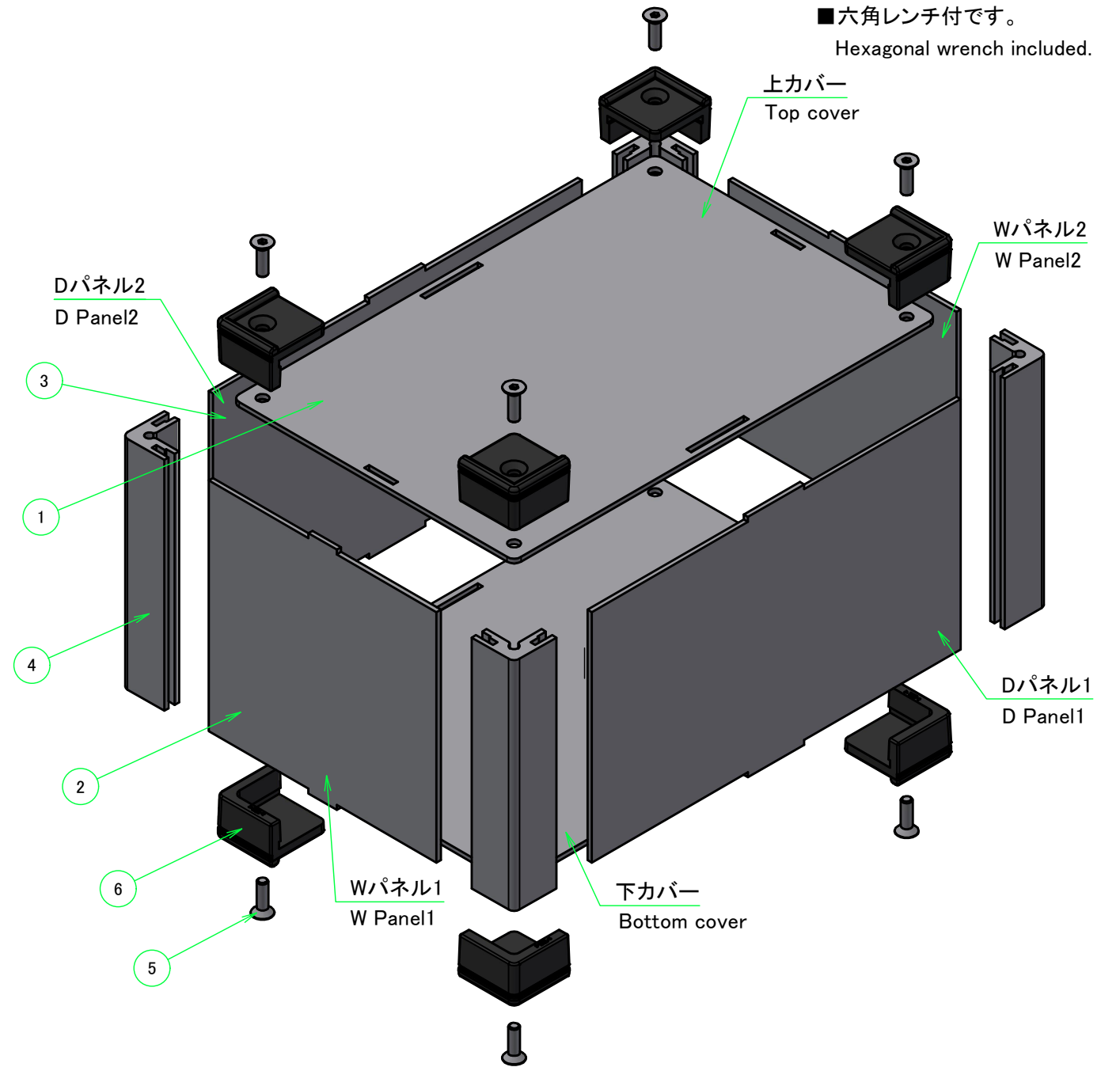

TAKACHI 株式会社タカチ電機工業 TAKACHI ELECTRONICS ENCLOSURE CO., LTD.			品名/Title コーナーガード付アルミフリーサイズケース CUSTOM SIZED ALUMINIUM FRAME BOX with CORNER GUARD	
承認/Approved	検図/Checked	製図/Created	型番/Product number ALGF□-□-□K20□ (W251~300, D201~300)	
中根	中根	常山	作成日/Date 2022/06/30	1 / 6

外視 / External View

Wパネル2 / W Panel 2

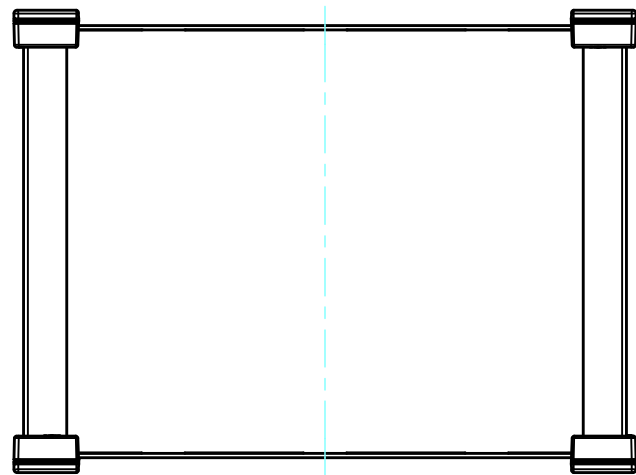

Dパネル2 / D Panel 2

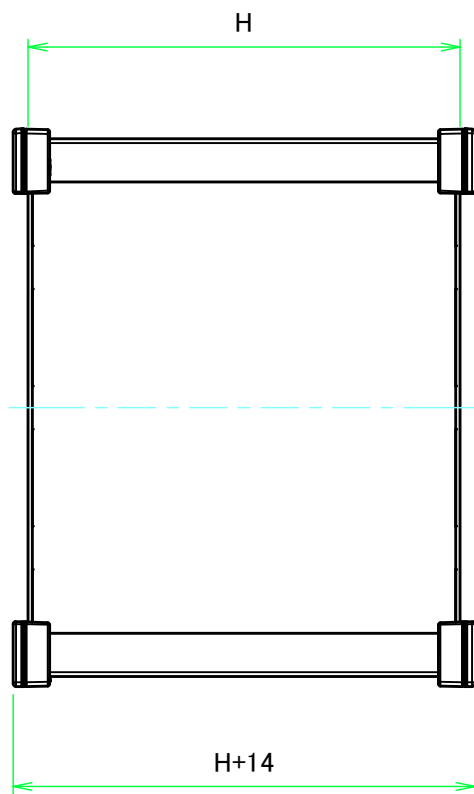

上カバー / Top cover

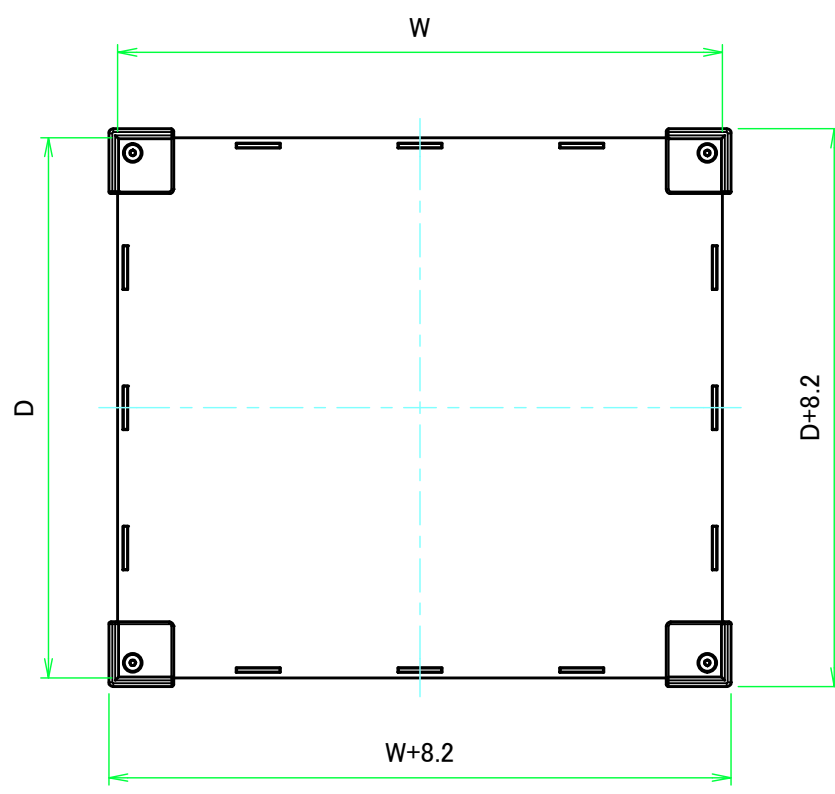

Dパネル1 / D Panel 1

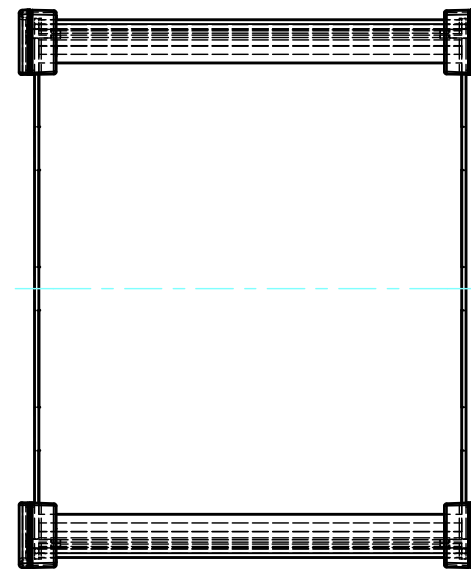

下カバー / Bottom cover

Wパネル間 有効寸法
Max dim. (between W panel) W-9.2

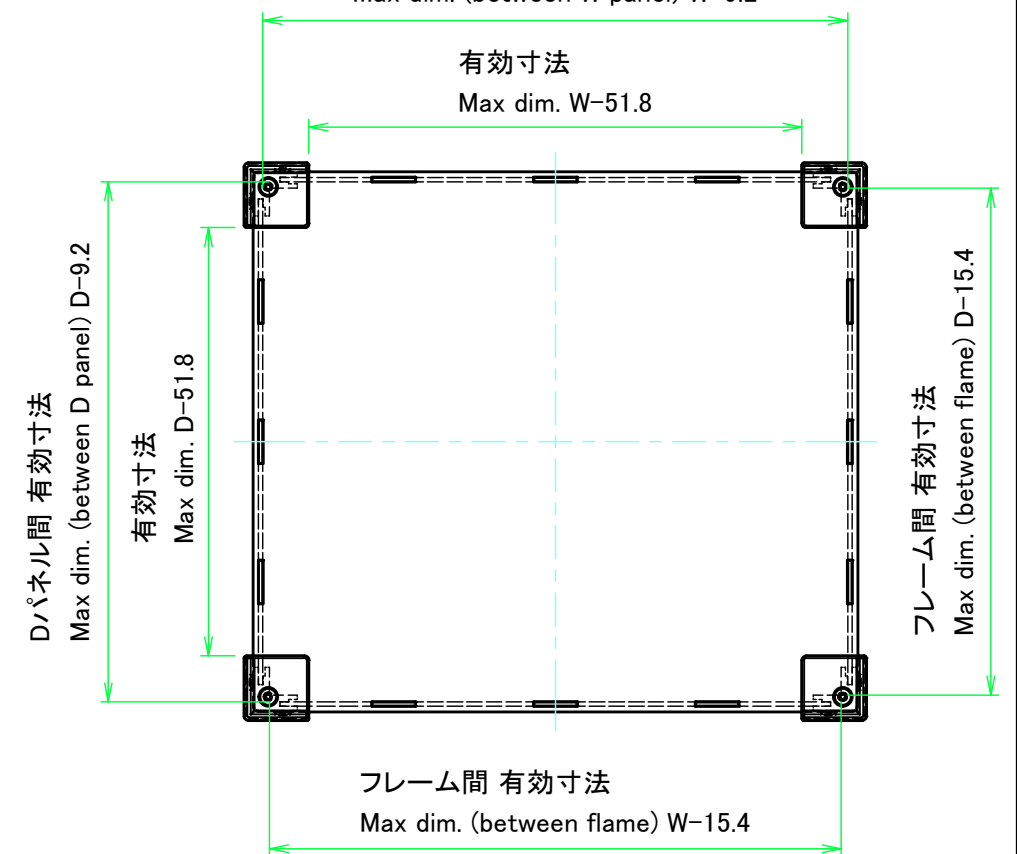

Wパネル1 / W Panel 1

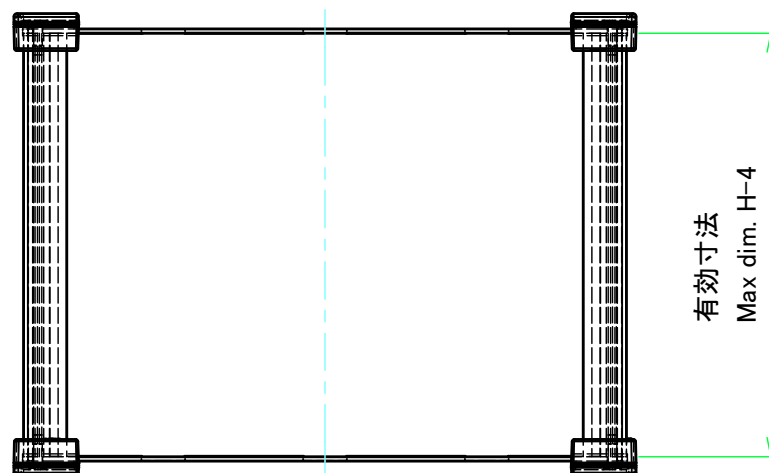

株式会社タカチ電機工業 TAKACHI ELECTRONICS ENCLOSURE CO., LTD.			品名/Title コーナーガード付アルミフリーサイズケース CUSTOM SIZED ALUMINIUM FRAME BOX with CORNER GUARD	尺度/Scale 1:3.5
承認/Approved	検図/Checked	製図/Created	型番/Product number ALGF□-□-□K20□ (W251~300, D201~300)	
中根	中根	常山	作成日/Date 2022/06/30	2 / 6

上下カバー / Top and Bottom cover

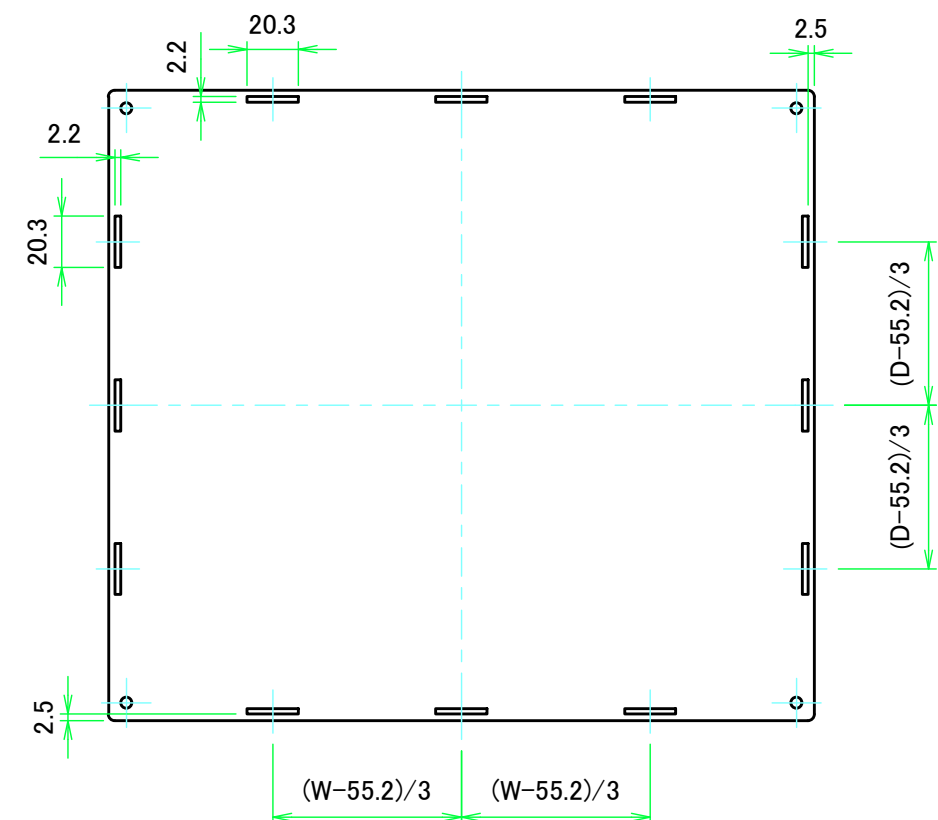
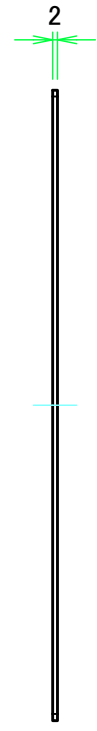
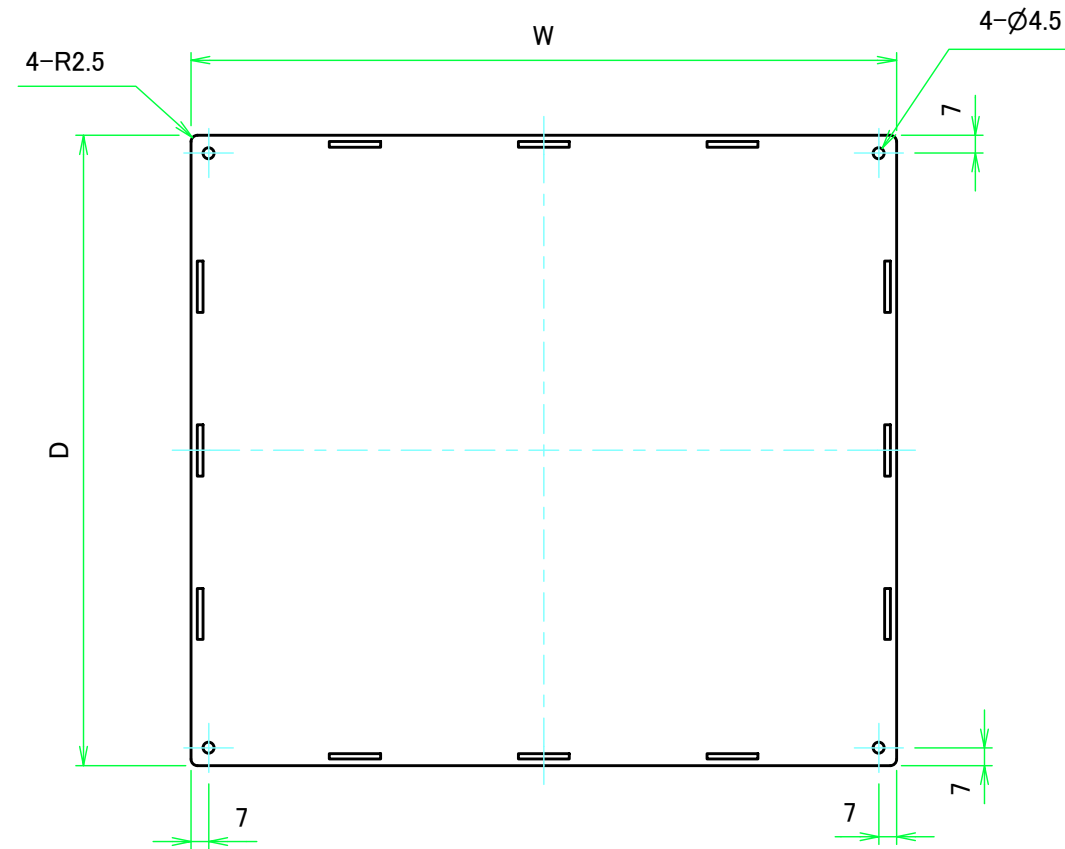

上カバー表面 / Top cover Frontside

上カバー裏面 / Top cover Backside

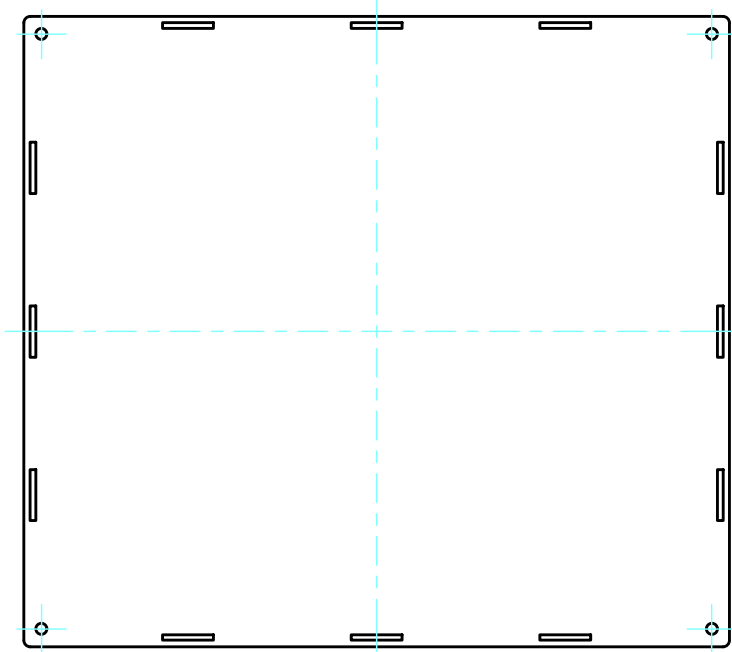
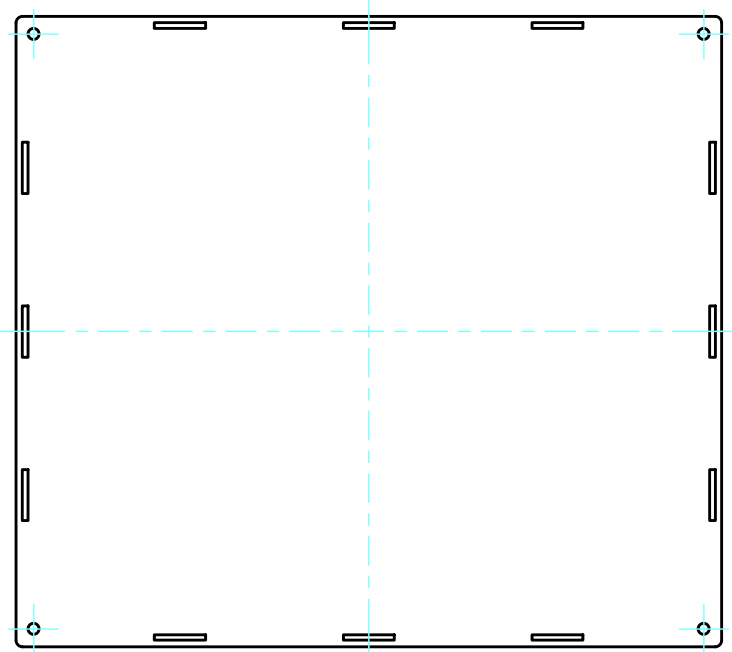

下カバー表面 / Bottom cover Frontside

下カバー裏面 / Bottom cover Backside

株式会社タカチ電機工業 TAKACHI ELECTRONICS ENCLOSURE CO., LTD.			品名/Title コーナーガード付アルミフリーサイズケース CUSTOM SIZED ALUMINIUM FRAME BOX with CORNER GUARD	尺度/Scale 1:3
承認/Approved	検図/Checked	製図/Created	型番/Product number ALGF□-□-□K20□ (W251~300, D201~300)	
中根	中根	常山	作成日/Date 2022/06/30	3 / 6

Wパネル / W Panel

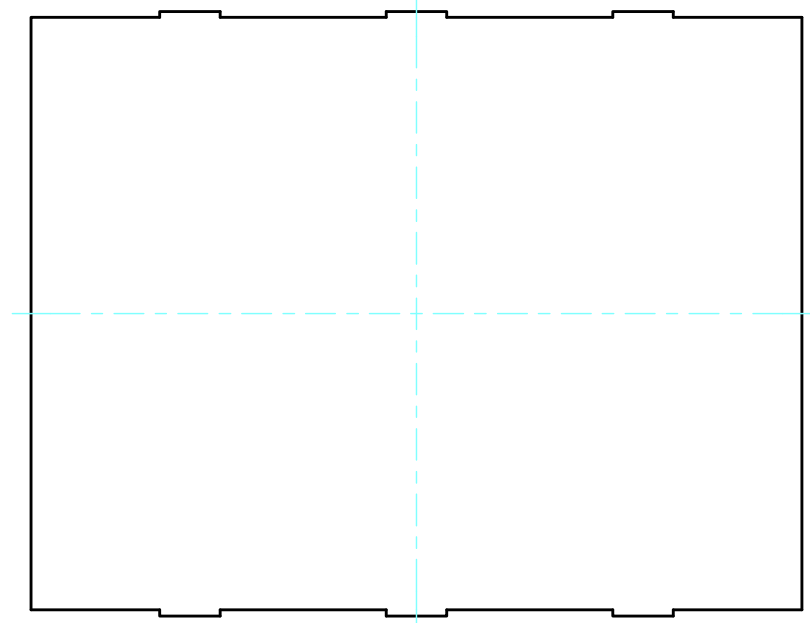
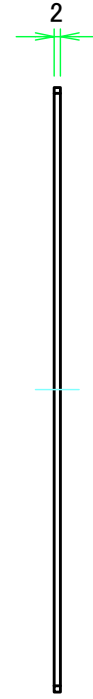
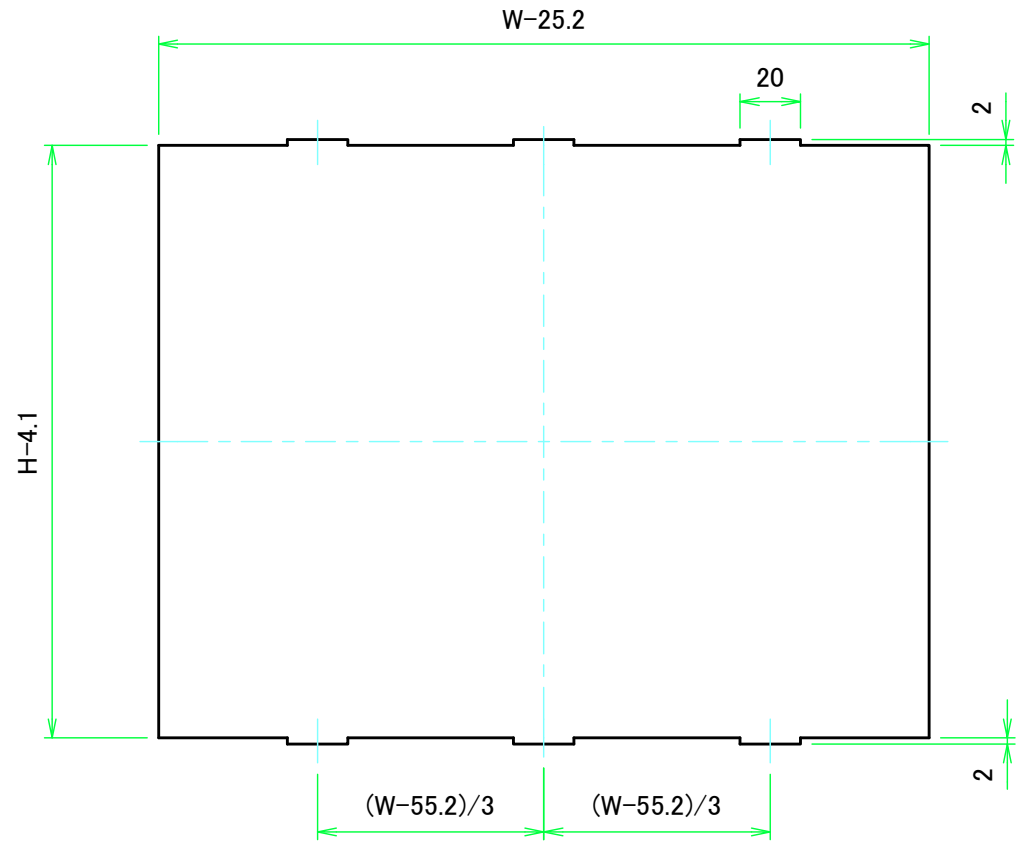

Wパネル1表面 / W Panel 1 Frontside

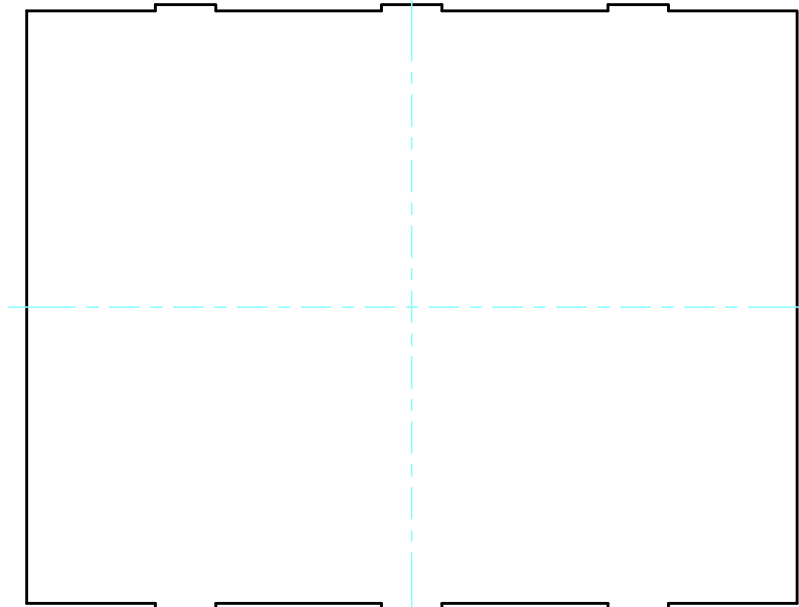

Wパネル1裏面 / W Panel 1 Backside

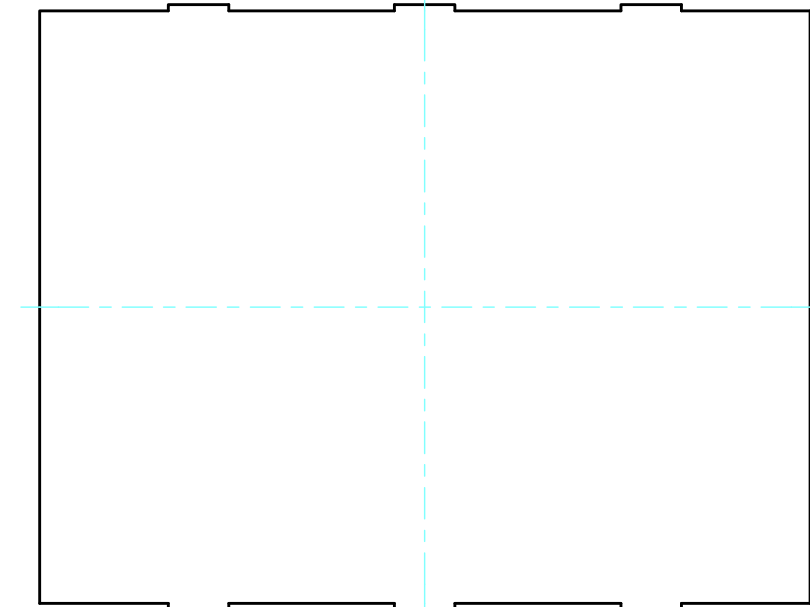

Wパネル2表面 / W Panel 2 Frontside

Wパネル2裏面 / W Panel 2 Backside

 株式会社タカチ電機工業 TAKACHI ELECTRONICS ENCLOSURE CO., LTD.			品名/Title コーナーガード付アルミフリーサイズケース CUSTOM SIZED ALUMINIUM FRAME BOX with CORNER GUARD	 尺度/Scale 1:2.5
承認/Approved	検図/Checked	製図/Created	型番/Product number ALGF□-□-□K20□ (W251~300, D201~300)	
中根	中根	常山	作成日/Date 2022/06/30	4 / 6

Dパネル / D Panel

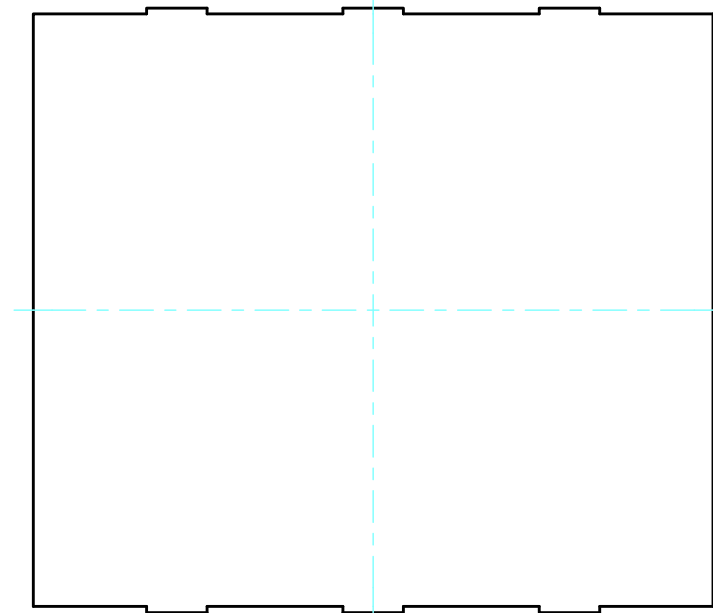
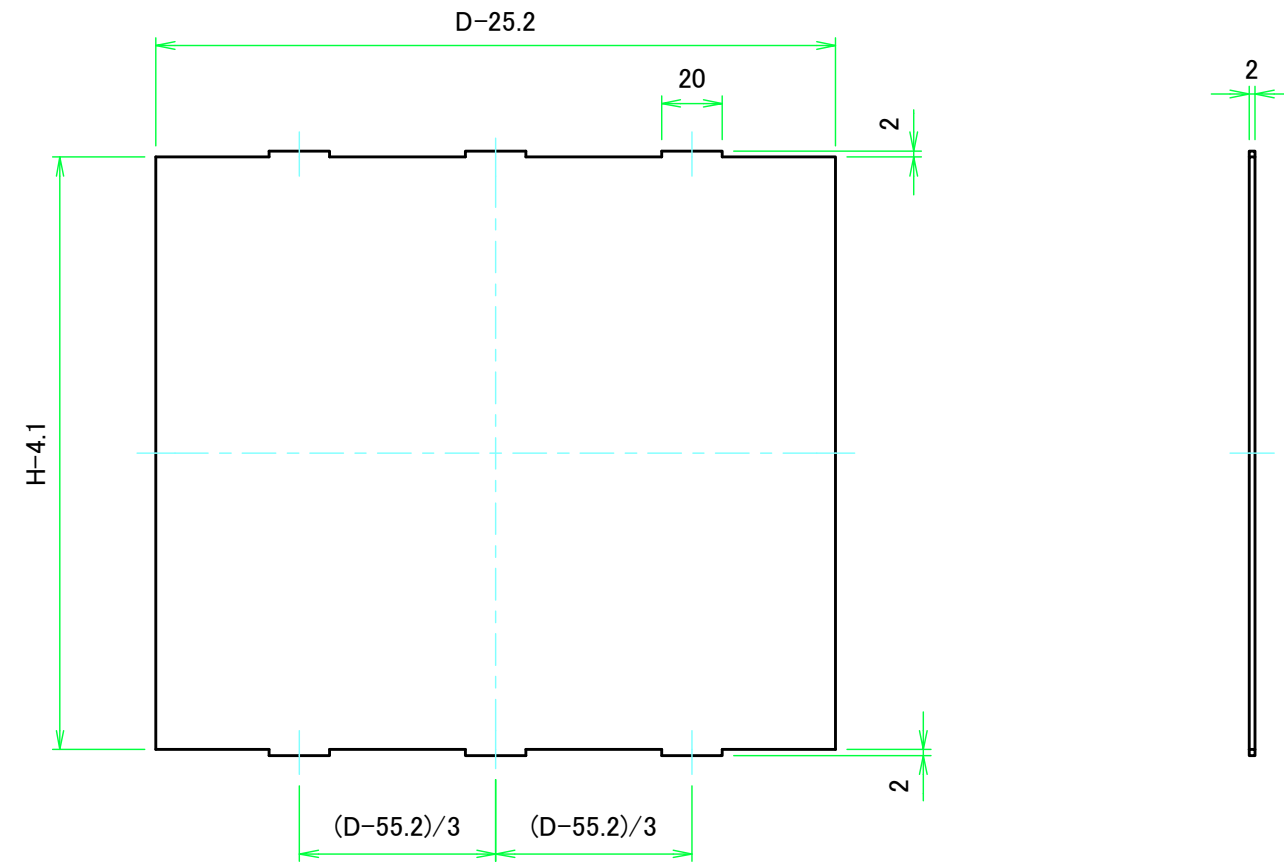

Dパネル1表面 / D Panel 1 Frontside

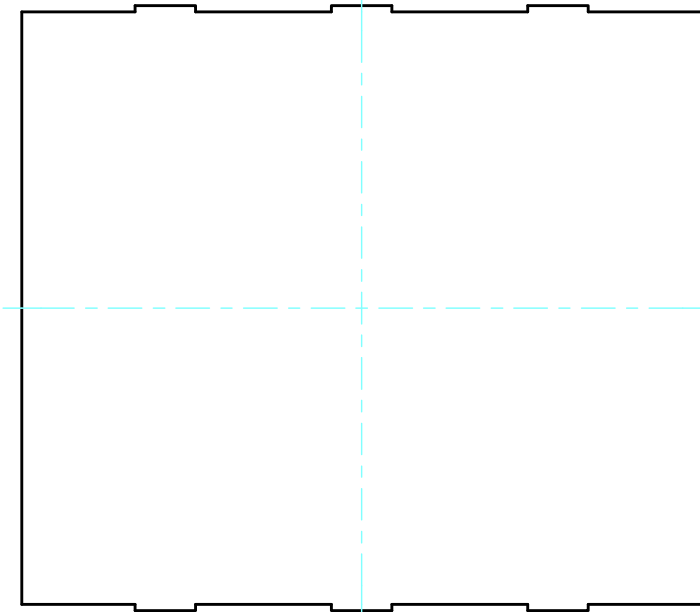

Dパネル1裏面 / D Panel 1 Backside

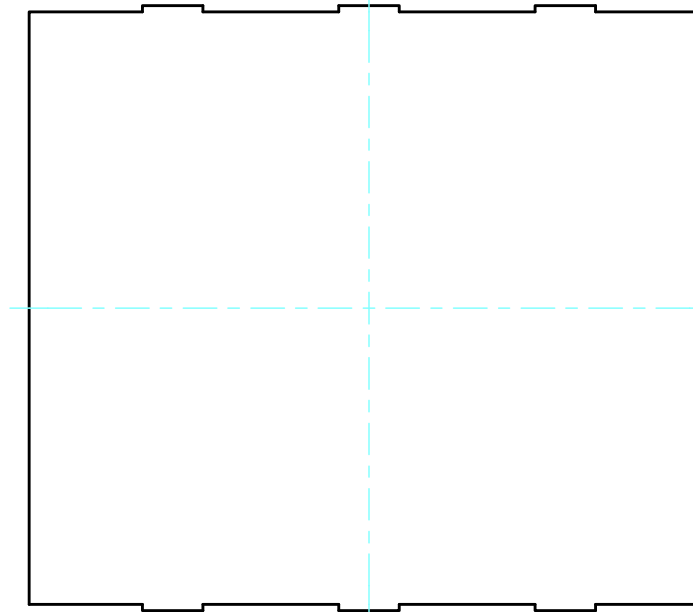

Dパネル2表面 / D Panel 2 Frontside

Dパネル2裏面 / D Panel 2 Backside

株式会社タカチ電機工業 <small>TAKACHI ELECTRONICS ENCLOSURE CO., LTD.</small>			品名/Title コーナーガード付アルミフリーサイズケース CUSTOM SIZED ALUMINIUM FRAME BOX with CORNER GUARD	尺度/Scale 1:2.5
承認/Approved 中根	検図/Checked 中根	製図/Created 常山	型番/Product number ALGF□-□-□K20□ (W251~300, D201~300)	
			作成日/Date 2022/06/30	5 / 6

コーナーガード / Corner guard

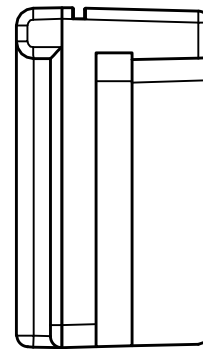
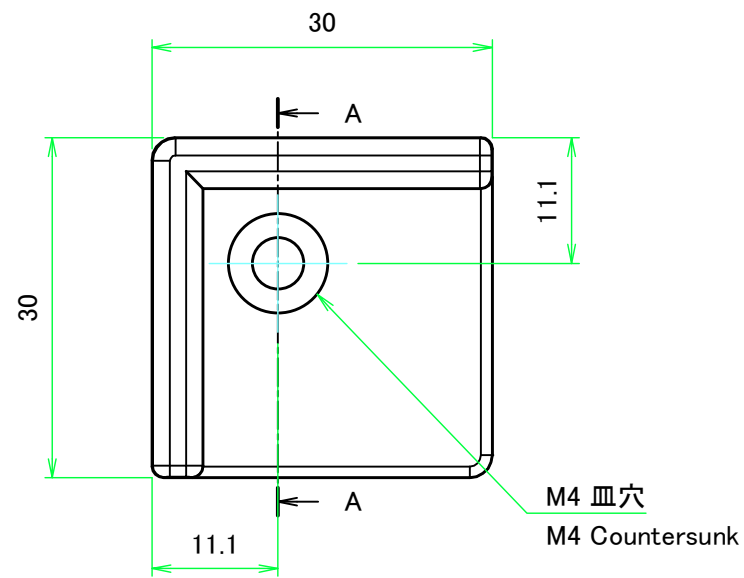
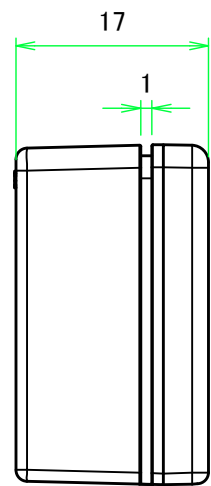
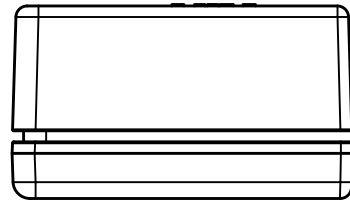

A-A (1.5:1)

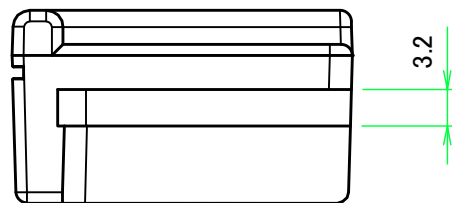
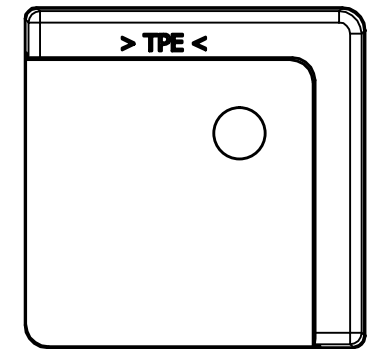
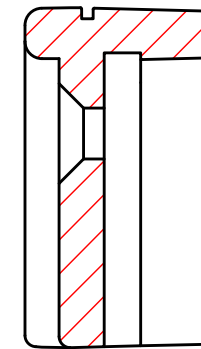

 株式会社タカチ電機工業 <small>TAKACHI ELECTRONICS ENCLOSURE CO., LTD.</small>			品名/Title コーナーガード付アルミフリーサイズケース CUSTOM SIZED ALUMINIUM FRAME BOX with CORNER GUARD	 尺度/Scale 1.5:1
承認/Approved	検図/Checked	製図/Created	型番/Product number ALGF□-□-□K20□ (W251~300, D201~300)	
中根	中根	常山	作成日/Date 2022/06/30	6 / 6